

SWEEPER-S-HG

Sweeper-S-HG has a slim, elegant design and minimal occupied area while offering widest opening clearance to allow big boxes, trolley, wheelchair, baby stroller to pass through with comfort. At the same time full-height swing leaves guarantees a high level of security and a long service life. High leaves not only exclude the possibility of unauthorized passage, but also prevent of transferring anything above the turnstile, as well as over jumping it. The use of impact-resistant tempered glass guarantees safety and gives a sophisticated modern look.



SWEEPER-S-HG MODEL WITH HIGH LEAVES

HIGH LEVEL OF PROTECTION IN THE MOST COMPACT BODY



Key features:

- BMDrive® - a reliable mechanism with a powerful BLDC gear motor ensures long-term, maintenance-free operation.
- The speed gate is equipped with a smart self-diagnostic system.
- An innovative controller with an OLED display and buttons allows for easy setup and configuration without the need for special programmers.
- Digital control of force and leaf speed, combined with safety sensors, prevents accidents and ensures the safety of individuals, even in cases of unauthorized passage.
- The sensor system enables the detection of individuals with luggage or allows for a free exit without the need for identification.
- Elegant cabinets come equipped with integrated LED lighting that displays the access status and card reader area.
- The housing design and top lid can be customized to meet specific preferences.
- Can be seamlessly integrated with any type of access control system.
- A wired remote control panel is included as part of the standard kit.
- Low power consumption.
- In the event of a power failure, the leaves can be manually opened (fail-safe).



TECHNICAL SPECIFICATIONS/

Model	Sweeper-S-HG 550	Sweeper-S-HG 900
Cabinet width, mm		174
Cabinet length, mm		1334
Cabinet height, mm		1010
Leaves height, mm		1500/1800
Passage width, mm	550	900
Opening/closing time, sec	0,6	0,8
Mechanism	BMDrive® servodrive (BLDC)	
Blocking system	ToothLock®	
Emergency mode (fire-alarm)	Free entry/exit (leaves are opened automatically)	
Power fail	Fail safe (gates could be opened manually — standard)	
MCBF, cycles	10 000 000	

Electrical Specifications:

Maximum power consumption, W	160
Voltage	From the AC (100-240)V, 50/60Hz; from a DC source 12 V
Indication	DotLights®, RFIDLights®, EdgeLights®

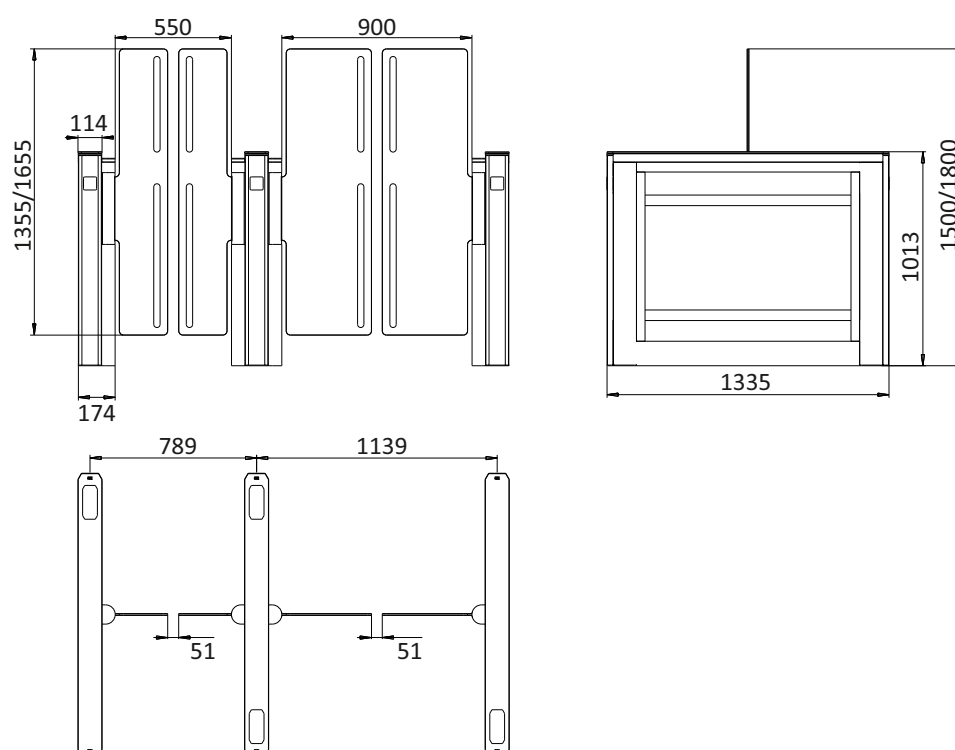

Finishing

Standard housing	Brushed SS AISI 304
Available housing	Brushed SS AISI 316; Polished SS AISI 304; Polished SS AISI 316; Powder coated RAL



Specifications are subject to change without prior notice



 www.tiso.global
 +380 (44) 291-21-11
 sales@tiso.global



STANDARD FEATURES

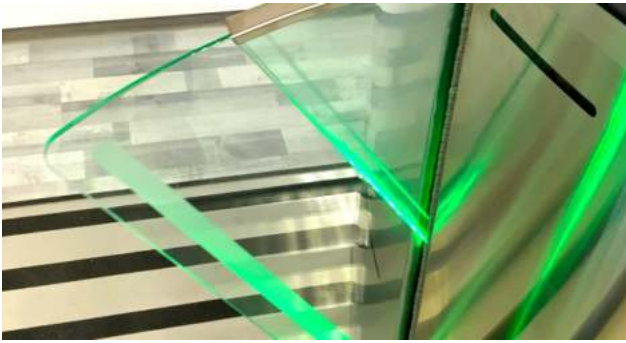

LEAFLIGHT®

Impressive illumination of the leaves can be in three colors (standard), marking the status of passage: blue - standby mode; green - access authorized; red - access denied.



CONTROL PANEL

The wired control panel goes in a standard set. Allows to implement a single passage, a free passage, as well as blocks an access and activates the anti-panic function.



SAFETY SENSORS, ANTI-TAILGATING FUNCTION

High-precision sensors that identify the unauthorized passage of two or more people (antitailgating function). At the same time safety sensors guarantee safe passage for people with luggage or trolleys - the gates won't close until the person finishes the passage.



UPS FUNCTION

A complex UPS system that automatically switches power to work from the back-up battery. This allows you to use all the functions of the speed gate in case of power fail.



LED INDICATIONS

Bright and attention-grabbing RFIDLIGHT® (LED light of card reader area) and DotLight® (LED lighting display showing access status).



PLACE FOR RFID INSTALLATION

Place for RFID installation is provided in the standard configuration of the speedgate.

ADDITIONAL OPTIONS /

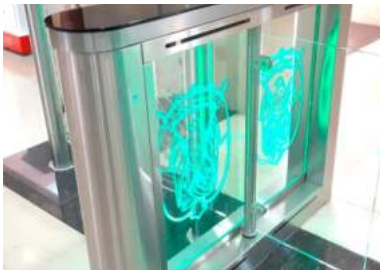

PATTERN APPLICATION

Unique signatures, customized patterns, logos and others can be placed on the leaves, housing or top lid of speed gates.



MP3 AUDIO MODULE

Audio signals for unauthorised access / authorised access / closing / opening / alarm.



KEYFOBS FOR RADIO REMOTE CONTROLLER

Minimalistic keyfobs for opening and blocking the passage.



INTEGRATION OF CUSTOMIZED ACS

Any access control systems upon request (e.g. RFID device, coin acceptor push button, fingerprint, face recognition, barcode and QRcode reader).



TWIC WIRELESS CONTROL PANEL

TiSO TWIC were developed for the remote control of multiple lines of turnstiles. The space saving 10" touch screen display can be located at a reception desk or within security control areas.



SUPER CAPASITOR

Maintenance of a free power package for emergency automatical one time opening of the speed gate.



FOOTPRINT ILLUMINATION

LED illumination of the footprint of the speed gate housing. The color of the light may vary depending on your request.

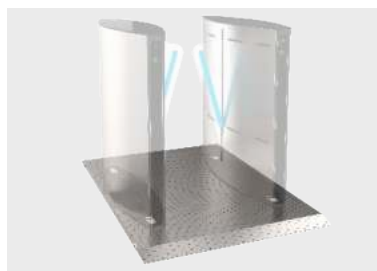

MOBILE PLATFORM

Ensures quick temporary speed gate installation. As well as can be installed in areas where it is impossible to drill the floor.



EXIT BUTTON

A convenient option that allows you to organize an exit by using a touch free button.

ADDITIONAL OPTIONS /

RANDOMIZER
RANDOMIZER
RANDOMIZER

RANDOMIZER

This mechanism automatically randomly selects a person for verification, without the influence of the human factor.



CARD COLLECTOR INTEGRATION

Possible to integrate the automatic card collector into the speed gate housing.



RFID READERS T-PROX MINI

Reader operates with 125 kHz cards, Mifare, Mifare Plus and mobile credentials U-Prox ID over NFC and over 2.4 GHz radio.



JUMPING OVER TOP LEAD ALARM

Weight sensors detect over 10 kg impact on the top lid and activate alarm.



COUNTER OF PASSAGES

Automatic counting of the number of passes.

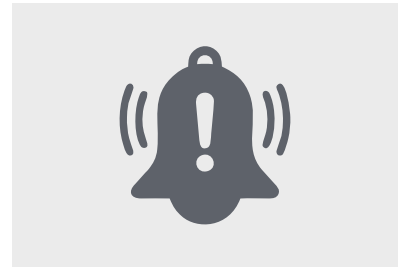

ALARM BUZZER

Sound alarm during unauthorised access.